

**PRODUCT SPECIFICATIONS**

Elkay Lustertone® Classic Stainless Steel 22" x 19-1/2" x 7-1/2" Single Classroom Sink w/Perfect Drain® Grid. Sink is manufactured from 18 gauge 304 Stainless Steel with a Lustrous Satin finish, Center drain placement, and Bottom only pads.

<b>Installation Type:</b>	Drop-in
<b>Material:</b>	304 Stainless Steel
<b>Special Features:</b>	Perfect Drain
<b>Finish:</b>	Lustrous Satin
<b>Gauge:</b>	18
<b>Sound Deadening:</b>	Bottom only pads
<b>Number of Bowls:</b>	1
<b>Sink Dimensions:</b>	22" x 19-1/2" x 7-1/2"
<b>Bowl 1 Dimensions:</b>	13-1/2" x 16" x 7-3/8"
<b>Drain Size:</b>	3-3/8" (86mm)
<b>Drain Location:</b>	Center
<b>Minimum Cabinet Size:</b>	27"
<b>Mounting Hardware:</b>	Part # 64090012 included for countertops up to 3/4" (19mm) thick
<b>Template Included:</b>	No
<b>Cutout Template #:</b>	<a href="#">1000001255</a>

Template is available for download at [elkay.com](#). CAD software will be required to open the template.

**Cutout Dimensions for Drop-in Installation:**

21-3/8" x 18-7/8" (543mm x 479mm) with 1-1/2" (38mm) corner radius

**Perfect Drain:** Seamlessly welded stainless steel collar eliminates the gap between a traditional drain and the sink for a more sanitary and gap free installation.



**Included with Product:** LKPDVR18B vandal-resistant Perfect Drain and grid assembly.

A Century of Tradition and Quality.

For more than 100 years, Elkay has been making innovative products and providing exceptional customer care. We take pride in offering plumbing products that make life easier, inspire change and leave the world a better place.



**Product Compliance:** ASME A112.19.3/CSA B45.4  
**Accessory:** ASME A112.18.2/CSA B125.2



Sinks are listed by IAPMO® as meeting the applicable requirements of the Uniform Plumbing Code®, International Plumbing Code®, and National Plumbing Code of Canada.

- [Clean and Care Manual \(PDF\)](#)
- [Installation Instructions \(PDF\) - 1000005236](#)
- [Installation Instructions \(PDF\) - 74180289 Disposer](#)
- [Installation Instructions \(PDF\) - 74180340-USA Drain](#)
- [Installation Instructions \(PDF\) - Garbage Disposer Compatibility Guide](#)
- [Limited Lifetime Warranty \(PDF\)](#)

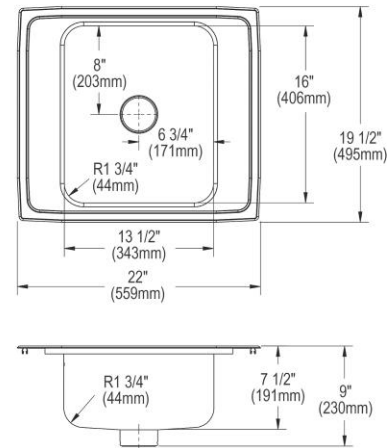

PART: \_\_\_\_\_ QTY: \_\_\_\_\_  
 PROJECT: \_\_\_\_\_  
 CONTACT: \_\_\_\_\_  
 DATE: \_\_\_\_\_  
 NOTES: \_\_\_\_\_  
 APPROVAL: \_\_\_\_\_

In keeping with our policy of continuing product improvement, Elkay reserves the right to change product specifications without notice. Please visit [elkay.com](#) for the most current version of Elkay product specification sheets. This specification describes an Elkay product with design, quality, and functional benefits to the user. When making a comparison of other producers' offerings, be certain these features are not overlooked.



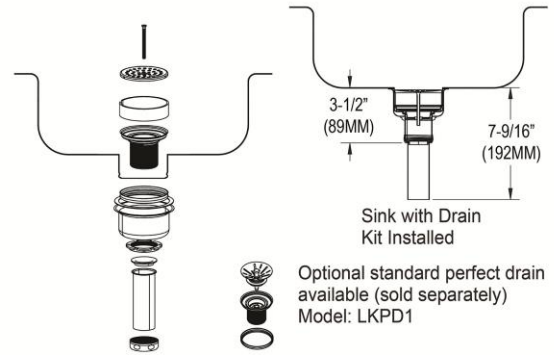
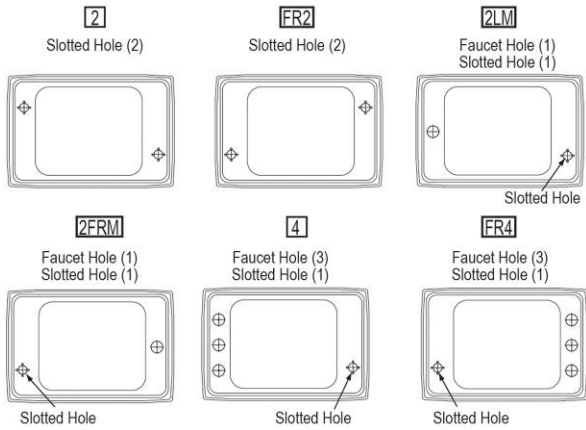

**Hole Drilling Configurations:**

1-1/2" (38mm) Diameter Faucet Holes on 4" (102mm) Centers  
1-1/8" (29mm) Diameter Slotted Hole

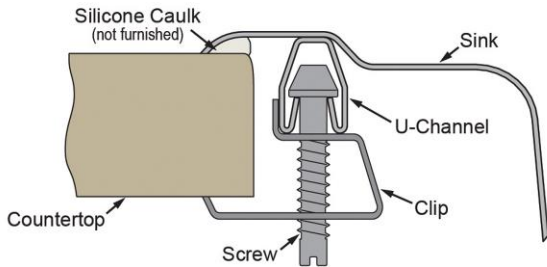

**Installation Profile:**



Included Accessories		
<a href="#">LKPDVR18B</a>	Perfect Drain <sup>®</sup> Chrome Plated Brass Body Vandal-resistant Strainer <a href="#">Spec Sheet (PDF)</a>	
Optional Accessories		
<a href="#">LKDS35</a>	3-1/2" Garbage Disposal Stopper / Strainer for use with Perfect Drain <sup>®</sup> -Satin Finish <a href="#">Spec Sheet (PDF)</a>	
<a href="#">LKPD1</a>	Perfect Drain <sup>®</sup> Fitting Type 304 Stainless Steel Body and Strainer <a href="#">Spec Sheet (PDF)</a>	
<a href="#">LKPDAD18B</a>	Perfect Drain <sup>®</sup> Chrome Plated Brass Body Strainer and LKADOS Tailpiece <a href="#">Spec Sheet (PDF)</a>	

In keeping with our policy of continuing product improvement, Elkay reserves the right to change product specifications without notice. Please visit [elkay.com](http://elkay.com) for the most current version of Elkay product specification sheets. This specification describes an Elkay product with design, quality, and functional benefits to the user. When making a comparison of other producers' offerings, be certain these features are not overlooked.