

**PRODUCT SPECIFICATIONS**

Elkay Crosstown® 18 Gauge Stainless Steel 22-1/2" x 18-1/2" x 9" Single Bowl Undermount Sink & Faucet Kit with Bottom Grid & Drain. Sink is manufactured from 18 gauge 304 Stainless Steel with a Polished Satin finish, Rear Center drain placement, and Full spray sides and bottom with Sides and Bottom pads.

<b>Installation Type:</b>	Undermount
<b>Material:</b>	304 Stainless Steel
<b>Finish:</b>	Polished Satin
<b>Gauge:</b>	18
<b>Sound Deadening:</b>	Full spray sides and bottom with Sides and Bottom pads
<b>Number of Bowls:</b>	1
<b>Sink Dimensions:</b>	22-1/2" x 18-1/2" x 9"
<b>Bowl 1 Dimensions:</b>	21" x 17" x 9"
<b>Drain Size:</b>	3-1/2" (89mm)
<b>Drain Location:</b>	Rear Center
<b>Minimum Cabinet Size:</b>	27"
<b>Mounting Hardware:</b>	Included
<b>Template Included:</b>	Yes
<b>Cutout Template #:</b>	<a href="#">1000003457</a>

Template is available for download at [elkay.com](#). CAD software will be required to open the template.



**Included with Product:**

Custom fit bottom grid CTXBG1915, deep strainer drain LKDD and faucet LKAV3031CR

A Century of Tradition and Quality. For more than 100 years, Elkay has been making innovative products and providing exceptional customer care. We take pride in offering plumbing products that make life easier, inspire change and leave the world a better place.



**Product Compliance:**

Faucet:

ASME A112.19.3/CSA B45.4  
ASME A112.18.1/CSA B125.1  
NSF 61  
NSF 372 (lead free)

Accessory:

ASME A112.18.2/CSA B125.2

**Installation Profile:**

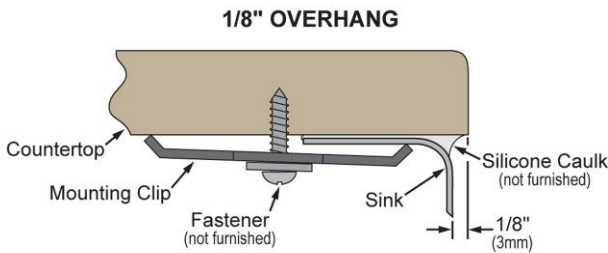

Designed to affix to the underside of any solid surface countertop.

- [Clean and Care Manual \(PDF\)](#)
- [Installation Instructions \(PDF\) - 1000005239](#)
- [Installation Instructions \(PDF\) - 1000005235 drain](#)
- [Warranty \(PDF\)](#)

PART: \_\_\_\_\_ QTY: \_\_\_\_\_

PROJECT: \_\_\_\_\_



CONTACT: \_\_\_\_\_

DATE: \_\_\_\_\_

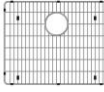

NOTES: \_\_\_\_\_

APPROVAL: \_\_\_\_\_

In keeping with our policy of continuing product improvement, Elkay reserves the right to change product specifications without notice. Please visit [elkay.com](#) for the most current version of Elkay product specification sheets. This specification describes an Elkay product with design, quality, and functional benefits to the user. When making a comparison of other producers' offerings, be certain these features are not overlooked.

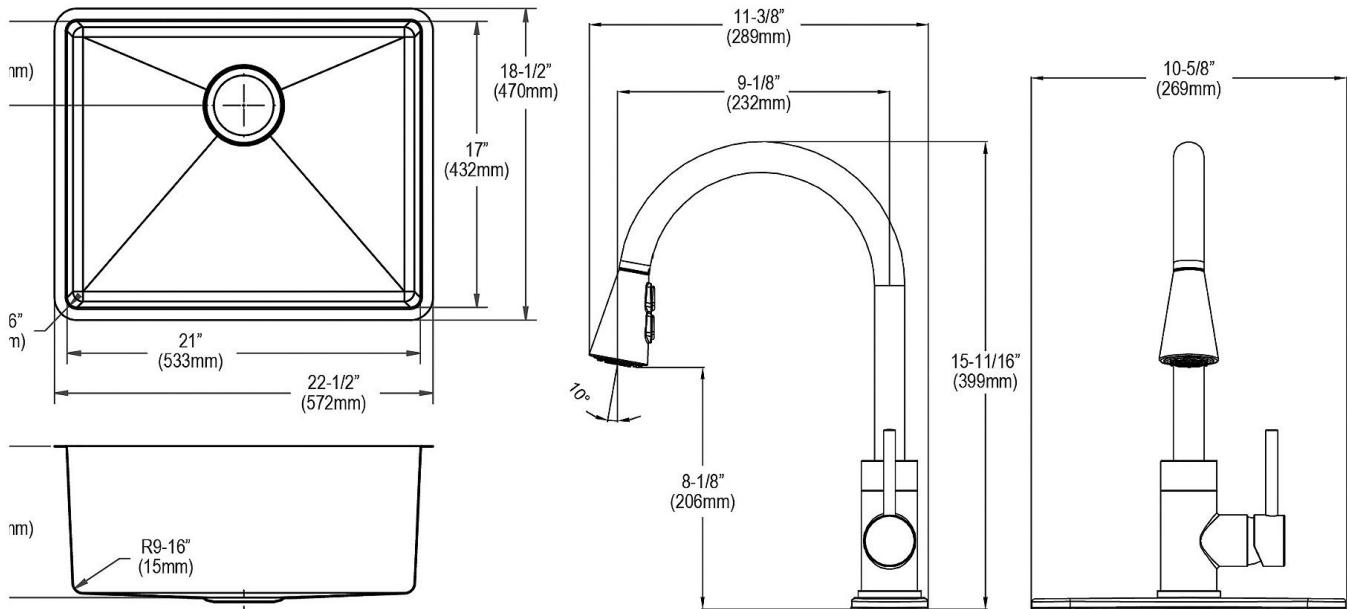
Included Accessories		
<a href="#">LKDD</a>	Elkay 3-1/2" Drain Fitting Deep Strainer Basket <a href="#">Spec Sheet (PDF)</a>	
<a href="#">CTXBG1915</a>	Elkay Crosstown Stainless Steel 19-1/2" x 15-1/2" x 1-1/4" Bottom Grid <a href="#">Spec Sheet (PDF)</a>	
<a href="#">LKAV3031CR</a>	Elkay Avado Single Hole Kitchen Faucet with Pull-down Spray and Forward Only Lever Handle Chrome <a href="#">Spec Sheet (PDF)</a>	



Optional Accessories		
<a href="#">CTXBG1915</a>	Elkay Crosstown Stainless Steel 19-1/2" x 15-1/2" x 1-1/4" Bottom Grid <a href="#">Spec Sheet (PDF)</a>	
<a href="#">LKDD</a>	Elkay 3-1/2" Drain Fitting Deep Strainer Basket <a href="#">Spec Sheet (PDF)</a>	
<a href="#">LKAV3031</a>	Elkay Avado Single Hole Kitchen Faucet with Pull-down Spray and Forward Only Lever Handle <a href="#">Spec Sheet (PDF)</a>	

In keeping with our policy of continuing product improvement, Elkay reserves the right to change product specifications without notice. Please visit [elkay.com](http://elkay.com) for the most current version of Elkay product specification sheets. This specification describes an Elkay product with design, quality, and functional benefits to the user. When making a comparison of other producers' offerings, be certain these features are not overlooked.