

PRODUCT SPECIFICATIONS

Dayton® Stainless Steel 19-1/16" x 13-3/4" x 1" Bottom Grid. Overall dimensions are 19-1/16" x 13-3/4" x 1".

Made of Stainless Steel

Bottom grids are:

- Custom designed to protect and cover the bottom of your sink.
- Properly positioned opening for convenient access to drain or disposer.
- Built from solid stainless steel to resist corrosion and provide years of service.

Material:	Stainless Steel
Finish:	Polished Stainless Steel
Dimensions:	19-1/16" x 13-3/4" x 1"
Fits Bowl Size(s):	21" x 15-3/4"

Special Note: For bowls with rear center drain opening.

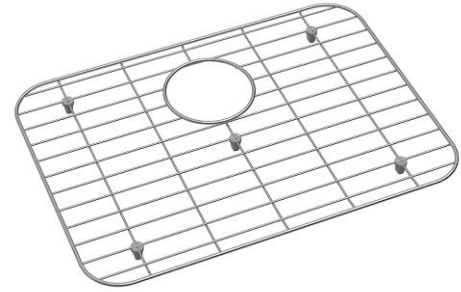

A Century of Tradition and Quality.

For more than 100 years, Elkay has been making innovative products and providing exceptional customer care. We take pride in offering plumbing products that make life easier, inspire change and leave the world a better place.

[Clean and Care Manual \(PDF\)](#)

[Clean and Care Manual \(PDF\)](#)

[Warranty \(PDF\)](#)

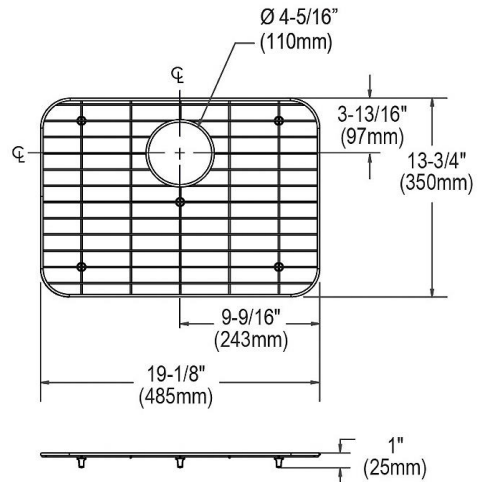

PART: _____ QTY: _____

PROJECT: _____

CONTACT: _____

DATE: _____

NOTES: _____

APPROVAL: _____

In keeping with our policy of continuing product improvement, Elkay reserves the right to change product specifications without notice. Please visit elkay.com for the most current version of Elkay product specification sheets. This specification describes an Elkay product with design, quality, and functional benefits to the user. When making a comparison of other producers' offerings, be certain these features are not overlooked.

In keeping with our policy of continuing product improvement, Elkay reserves the right to change product specifications without notice. Please visit elkay.com for the most current version of Elkay product specification sheets. This specification describes an Elkay product with design, quality, and functional benefits to the user. When making a comparison of other producers' offerings, be certain these features are not overlooked.