

**PRODUCT SPECIFICATIONS**

Lustertone® Classic Stainless Steel 31" x 22" x 5-1/2" Single Bowl Drop-in ADA Sink with Quick-clip. Sink is manufactured from 18 gauge 304 Stainless Steel with a Lustrous Satin finish, Rear Center drain placement, and Bottom only pads.

<b>Installation Type:</b>	Drop-in
<b>Material:</b>	304 Stainless Steel
<b>Special Features:</b>	Quick-Clip Mounting System
<b>Finish:</b>	Lustrous Satin
<b>Gauge:</b>	18
<b>Sound Deadening:</b>	Bottom only pads
<b>Number of Bowls:</b>	1
<b>Sink Dimensions:</b>	31" x 22" x 5-1/2"
<b>Bowl 1 Dimensions:</b>	28" x 16" x 5-3/8"
<b>Drain Size:</b>	3-1/2" (89mm)
<b>Drain Location:</b>	Rear Center
<b>Minimum Cabinet Size:</b>	36"
<b>Mounting Hardware:</b>	Included for 3/4" (19mm) countertop
<b>Template Included:</b>	No
<b>Cutout Template #:</b>	<a href="#">1000001239</a>

Template is available for download at [elkay.com](#). CAD software will be required to open the template.

**Cutout Dimensions for Drop-in Installation:**

30-3/8" x 21-3/8" (772mm x 543mm) with 1-1/2" (38mm) corner radius

**Hole Drilling Configurations:**

1-1/2" (38mm) Diameter Faucet Holes on 4" (102mm) Centers

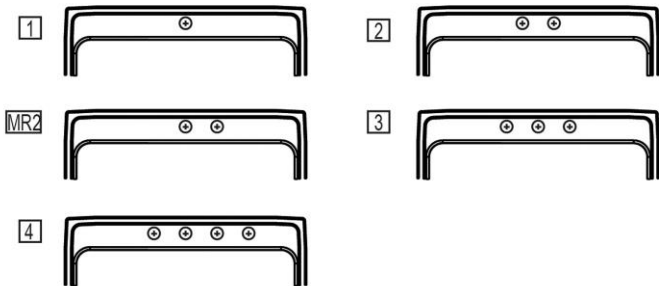

A Century of Tradition and Quality. For more than 100 years, Elkay has been making innovative products and providing exceptional customer care. We take pride in offering plumbing products that make life easier, inspire change and leave the world a better place.



**Product Compliance:** ADA & ICC A117.1  
ASME A112.19.3/CSA B45.4



Sinks are listed by IAPMO® as meeting the applicable requirements of the Uniform Plumbing Code®, International Plumbing Code®, and National Plumbing Code of Canada.



Complies with ADA & ICC A117.1 accessibility requirements when installed according to the requirements outlined in these standards.

[Clean and Care Manual \(PDF\)](#)  
[Installation Instructions \(PDF\) - 1000005236](#)  
[Warranty \(PDF\)](#)

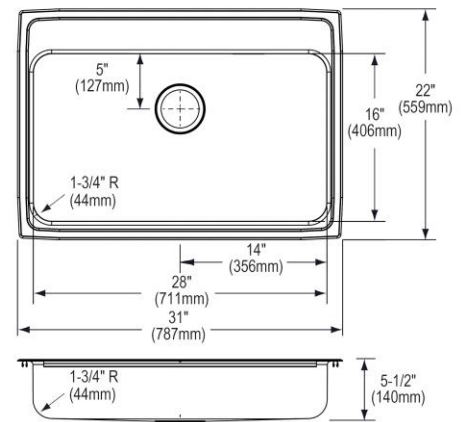





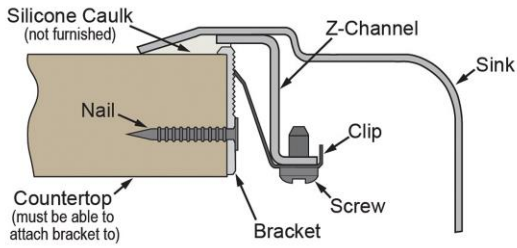

PART: \_\_\_\_\_ QTY: \_\_\_\_\_  
 PROJECT: \_\_\_\_\_  
 CONTACT: \_\_\_\_\_  
 DATE: \_\_\_\_\_  
 NOTES: \_\_\_\_\_  
 APPROVAL: \_\_\_\_\_

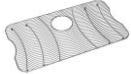
In keeping with our policy of continuing product improvement, Elkay reserves the right to change product specifications without notice. Please visit [elkay.com](#) for the most current version of Elkay product specification sheets. This specification describes an Elkay product with design, quality, and functional benefits to the user. When making a comparison of other producers' offerings, be certain these features are not overlooked. Latest version of the spec sheet available: [https://www.elkayfiles.com/spec-sheets/LRADQ312255\\_spec.pdf](https://www.elkayfiles.com/spec-sheets/LRADQ312255_spec.pdf)

**Installation Profile:**



Optional Accessories		
<a href="#">LKWOBG2816SS</a>	Elkay Stainless Steel 26-1/2" x 14-13/16" x 1" Bottom Grid <a href="#">Spec Sheet (PDF)</a>	
<a href="#">CB1713</a>	Elkay Hardwood 13-1/2" x 17" x 1" Cutting Board <a href="#">Spec Sheet (PDF)</a>	
<a href="#">CBS1316</a>	Hardwood 14-1/2" x 17" x 3/4" Cutting Board <a href="#">Spec Sheet (PDF)</a>	
<a href="#">LK99</a>	Deluxe 3-1/2" Drain Type 304 Stainless Steel Body Strainer Basket Rubber Seal and Tailpiece <a href="#">Spec Sheet (PDF)</a>	
<a href="#">LKAD35</a>	3-1/2" Drain Fitting" Stainless Steel Body Strainer Basket and Offset Tailpiece <a href="#">Spec Sheet (PDF)</a>	
<a href="#">LKGT1041</a>	Elkay Gourmet Single Hole Kitchen Faucet Pull-out Spray and Lever Handle with Hi and Mid-rise Base Options <a href="#">Spec Sheet (PDF)</a>	
<a href="#">LKWERBSS</a>	Elkay® Stainless Steel 15-3/8" x 12-3/8" x 5-7/16" Rinsing Basket <a href="#">Spec Sheet (PDF)</a>	

In keeping with our policy of continuing product improvement, Elkay reserves the right to change product specifications without notice. Please visit [elkay.com](http://elkay.com) for the most current version of Elkay product specification sheets. This specification describes an Elkay product with design, quality, and functional benefits to the user. When making a comparison of other producers' offerings, be certain these features are not overlooked. Latest version of the spec sheet available: [https://www.elkayfiles.com/spec-sheets/LRADQ312255\\_spec.pdf](https://www.elkayfiles.com/spec-sheets/LRADQ312255_spec.pdf)